



# HMT370EX Series intrinsically safe humidity and temperature transmitters

For operation in up to Zone 0 / 20



## Features

- Measures RH and T and outputs also dew point temperature, wet-bulb temperature, absolute humidity, mixing ratio, water concentration, water mass fraction, water vapor pressure, and enthalpy
- Intrinsically safe (Exi)
- Designed for harsh conditions
- Temperature range between -70 ... +180 °C (-94 ... +356 °F) depending on the probe option
- Vaisala HUMICAP® sensor features high accuracy, excellent long-term stability, and negligible hysteresis
- Graphical LCD display
- Traceable calibration (certificate included)
- Compatible with Vaisala Insight PC software

Vaisala HMT370EX Series HUMICAP® Humidity and Temperature Transmitters are the ideal solution for measuring humidity in hazardous areas. The intrinsically safe and robust transmitter operates safely and reliably even in the most hazardous classifications, such as Zone 0. The next-generation HMT370EX transmitters can be used as a replacement of the long-running HMT360 transmitter series.

### Interchangeable probes and detachable probe module

HMT370EX offers several probe options for different applications:

- HMP371 - wall mount
- HMP373 - confined spaces
- HMP374 - pressurized spaces
- HMP375 - high temperature
- HMP377 - high humidity
- HMP378 - pressurized pipelines

Thanks to the detachable probe module, probes can be easily replaced and removed for calibration outside the hazardous area without removing the

entire transmitter. Attaching new probes involves minimal reconfiguration, as up-to-date settings can be restored from the transmitter.

### Intrinsically safe and robust

The entire HMT370EX transmitter can be installed directly in hazardous areas. It can withstand continuous exposure to potentially explosive environments that contain flammable gases or dust. Operation in either gas or dust environments requires no additional protective enclosures. A rugged design,

combined with trouble-free operation, ensures a long-term solution for monitoring humidity and dew point in potentially explosive environments.

### Easy configuration access with local display and Insight PC software

Output configuration and measurement calibration and adjustment can be carried out directly on the local display interface. For additional configuration and monitoring options, you can connect the transmitter to Vaisala Insight PC software with an accessory USB cable. The probe and transmitter body can be connected to Insight for configuration either together as one unit or separately.

# Interchangeable probes for HMT370EX intrinsically safe humidity and temperature transmitter

## HMP371 for wall mounting

Temperature range	-40 ... +60 °C (-40 ... +140 °F)
Probe diameter	12 mm (0.47 in)



HMP371 probe shown with a stainless steel netting filter

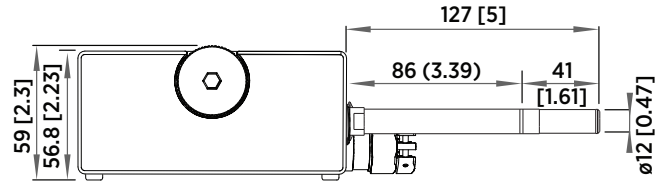

Dimensions in mm (inches)

## HMP373 for confined spaces

Temperature range with teflon cable	-40 ... +120 °C (-40 ... +248 °F)
Temperature range with rubber cable	-40 ... +80 °C (-40 ... +176 °F)
Probe cable length	2, 5 or 10 meters (6 ft 7 in, 16 ft 5 in, 32 ft 10 in)
Probe diameter	12 mm (0.47 in)

### Installation

Duct installation kit	210697
Cable gland M20x1.5 with splitting seal	HMP247CG
Swagelok for 12mm probe, 1/2" NPT thread	SWG12NPT12

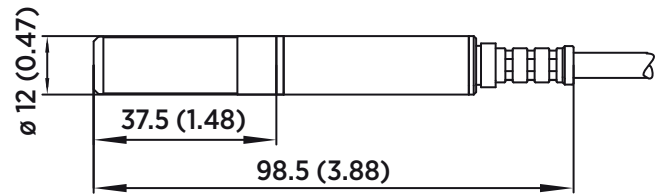

Dimensions in mm (inches)

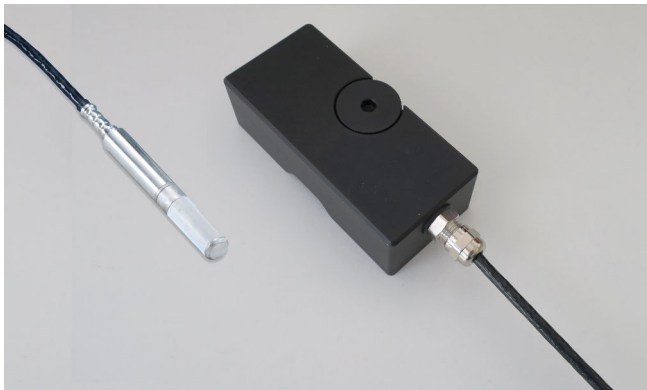

The small-sized HMP373 probe fits into tight spaces: shown connected with a teflon cable

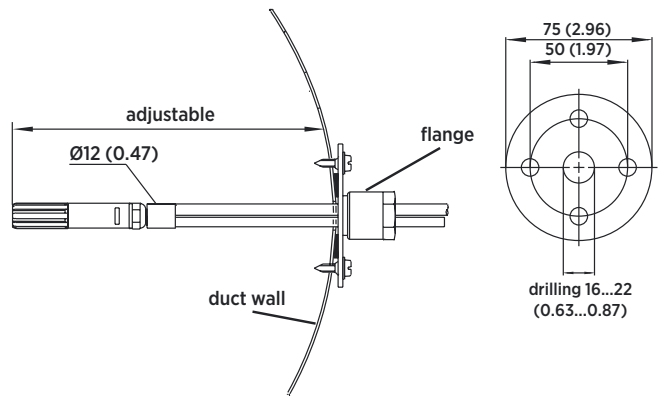

Left: Installation kit for duct mounting. Right: Installation flange. Aluminum or stainless steel.

### HMP374 for high pressure

Temperature range	-70 ... +180 °C (-94 ... +356 °F)
Pressure range	0 ... 10 MPa
Probe cable length	2, 5 or 10 meters (6 ft 7 in, 16 ft 5 in, 32 ft 10 in)
Probe diameter	12 mm (0.47 in)
Fitting body M22x1.5	17223
Fitting body NPT1/2	17225



HMP374 is designed for measurement in pressurized spaces or vacuum chambers

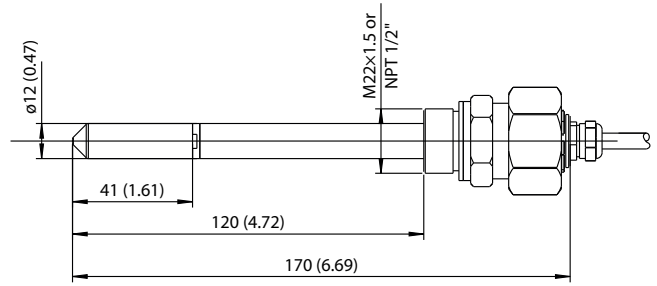

Dimensions in mm (inches)

### HMP375 for high temperature

Temperature range	-70 ... +180 °C (-94 ... +356 °F)
Probe cable length	2, 5 or 10 meters (6 ft 7 in, 16 ft 5 in, 32 ft 10 in)
Probe diameter	13.5 mm (0.53 in)
<b>Installation</b>	
Mounting flange	210696
Cable gland M20x1.5 with splitting seal	HMP247CG

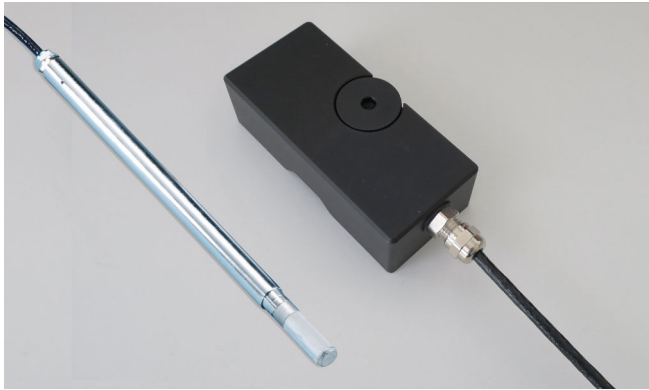

HMP375 is designed for high temperature environments

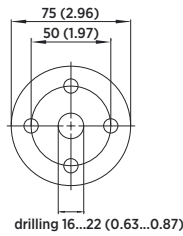
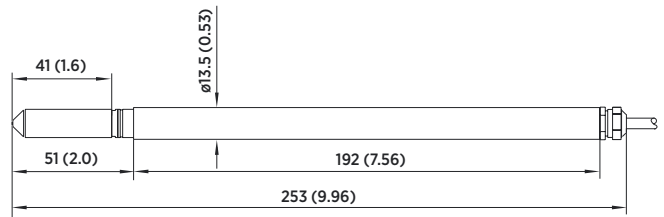

HMP375 probe and stainless steel installation flange. Dimensions in mm (inches).

### HMP377 for high humidities

Temperature range	-70 ... +180 °C (-94 ... +356 °F)
Probe cable length	2, 5 or 10 meters (6 ft 7 in, 16 ft 5 in, 32 ft 10 in)
Probe diameter	12 mm (0.47 in)
<b>Installation</b>	
Duct installation kit	210697
Cable gland M20x1.5 with splitting seal	HMP247CG
Swagelok for 12 mm probe, 3/8" ISO thread	SWG12ISO38
Swagelok for 12 mm probe, 1/2" NPT thread	SWG12NPT12



HMP377 is constructed to be installed in environments with high humidities

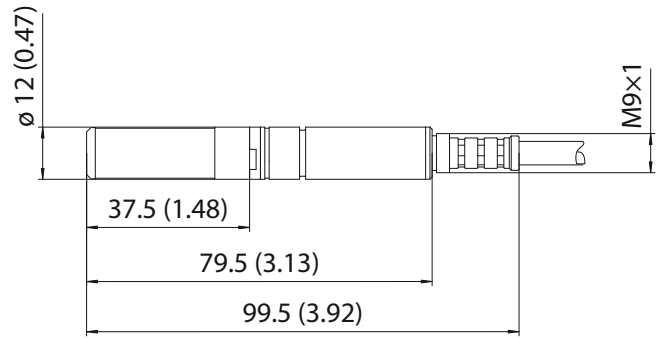

Dimensions in mm (inches)

### HMP378 for pressurized pipelines

Temperature range	-70 ... +180 °C (-94 ... +356 °F)
Pressure range	0 ... 4 MPa
Probe cable length	2, 5 or 10 meters (6 ft 7 in, 16 ft 5 in, 32 ft 10 in)
Probe diameter	13.5 mm/12 mm (0.53 in/0.47 in)
Available probe lengths	226 mm/448 mm (8.90 in/17.6 in)
<b>Installation</b>	
Fitting body ISO1/2 solid structure	DRW212076SP
Fitting body NPT1/2 solid structure	NPTFITBODASP
Ball valve ISO 1/2 with welding joint	BALLVALVE-1

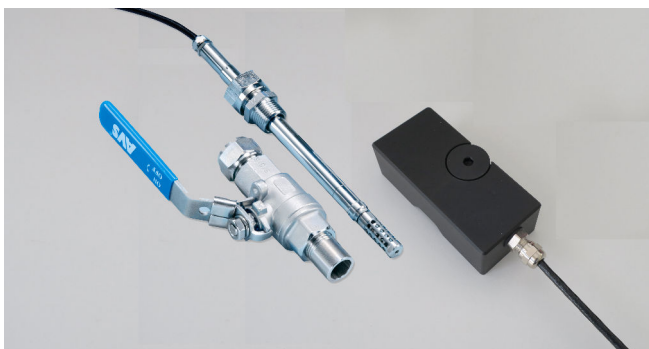

HMP378 enables flexible installation in pressurized pipelines

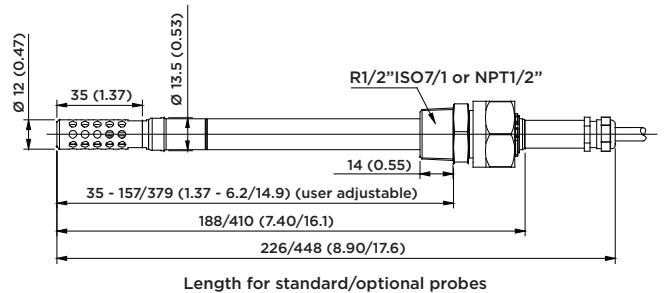

Dimensions in mm (inches)

# Technical data

## Measurement performance

### Relative humidity

Measurement range	0 ... 100 %RH
Accuracy at +23 °C (+73.4 °F) <sup>1)</sup>	±0.8 %RH (0 ... 90 %RH)
Factory calibration uncertainty <sup>2)</sup>	±0.5 %RH (0 ... 40 %RH) ±0.8 %RH (40 ... 95 %RH)
T <sub>63</sub> response time	15 s
Sensor options	HUMICAP® R2 HUMICAP® L2 <sup>3)</sup>

### Temperature

Measurement range	-70 ... +180 °C (-94 ... +356 °F)
Accuracy at +23 °C (+73.4 °F) <sup>1)</sup>	±0.1 °C (±0.18 °F)
Factory calibration uncertainty <sup>2)</sup>	±0.1 °C (±0.18 °F) at +23 °C (+73.4 °F)
Sensor	Pt1000 RTD Class F0.1 IEC 60751

### Other available measurement parameters<sup>3)</sup>

Dew point temperature, wet-bulb temperature, absolute humidity, mixing ratio, water concentration, water mass fraction, water vapor pressure, and enthalpy

- 1) Defined against calibration reference. Including non-linearity, hysteresis, and repeatability.
- 2) Defined as ±2 standard deviation limits. Small variations possible; see calibration certificate.
- 3) For specifications, see HMT370EX User Guide

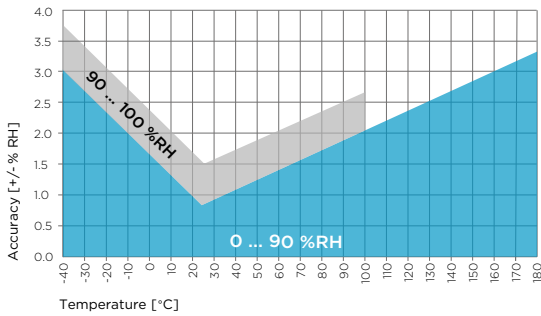

Humidity measurement accuracy as function of temperature

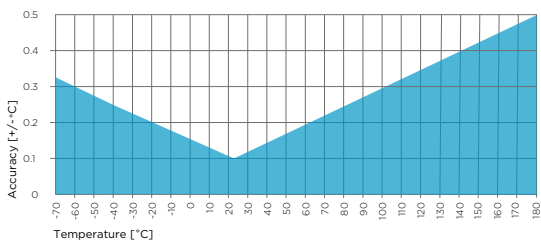

Temperature measurement accuracy over full range

## Operating environment

Operating temperature for electronics	-40 ... +60 °C (-40 ... +140 °F)
Operating temperature with display	-20 ... +60 °C (-4 ... +140 °F)
Storage temperature	-40 ... +70 °C (-40 ... +158 °F)
Pressure range	See probe specifications

## Compliance

EMC compatibility	EN 61326-1, industrial environment
Compliance marks	RCM, CE, China RoHS

## Inputs and outputs

Operating voltage	12 ... 28 V
Analog outputs	2 outputs (two-wire, 4 ... 20 mA) Connection via safety barriers
Typical accuracy of analog outputs at +20 °C	±0.0625 % full scale
Typical temperature dependence of analog outputs	0.005 % / °C (0.005 % / °F) full scale
Service port connection	USB cable 219690
Display options	<ul style="list-style-type: none"> <li>Graphical LCD display</li> <li>Model without display</li> </ul>

## Mechanical specifications

Connections	Screw terminals, 0.33 ... 2.0 mm <sup>2</sup>
Cable glands	M20 x 1.5
Conduit fitting	NPT 1/2" and M16
Housing material	EN AW-6082
Housing weight	LCD transmitter: 1500 g (3.3 lb) LED transmitter: 1520 g (3.35 lb) HMP371 fixed probe: 320 g (0.7 lb)
IP rating	IP66 (NEMA4)

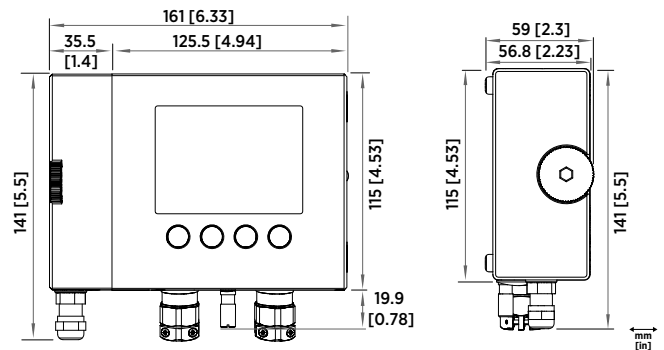

HMT370EX dimensions in millimeters and [inches]

## Ex classifications by region

### Europe (ATEX)

Gas classification EU (2014/34/EU)	II 1 G Ex ia IIC T4 Ga
Dust classification	II 1 D Ex ia IIIC T <sub>200</sub> 85 °C Da
Safety factors	U <sub>i</sub> = 28 VDC, I <sub>i</sub> = 100 mA, C <sub>i</sub> = 12.1 nF, P <sub>i</sub> = 700 mW, L <sub>i</sub> = 16 μH
Environmental specifications	
T <sub>amb</sub>	-40 ... +60 °C (-40 ... +140 °F)
P <sub>amb</sub>	0.8 ... 1.1 bar

### International (IECEx)

Gas classification	Ex ia IIC T4 Ga
Dust classification	II 1 D Ex ia IIIC T <sub>200</sub> 85 °C Da
Safety factors	U <sub>i</sub> = 28 VDC, I <sub>i</sub> = 100 mA, C <sub>i</sub> = 12.1 nF, P <sub>i</sub> = 700 mW, L <sub>i</sub> = 16 μH
Environmental specifications	
T <sub>amb</sub>	-40 ... +60 °C (-40 ... +140 °F)
P <sub>amb</sub>	0.8 ... 1.1 bar

### Japan (CML)

Ex classification	Ex ia IIC T4 Ga Ex ia IIIC T <sub>200</sub> 85°C Da CML 21JPN2417X
-------------------	--

### Region classifications planned for future releases

USA
Canada
China
Korea

## Transmitter accessory availability

Accessory	Part number	Models
<b>Cable lead-through accessories</b>		
Cable gland M20 x 1.5 for Ø 5 ... 11 mm cable	265207SP	All models
Cable gland M20 x 1.5 for Ø 10 ... 14 mm cable	265208SP	All models
Conduit fitting M16	265243SP	All models
Conduit fitting NPT1/2"	265240SP	All models
Dummy plug (Ex, 2 pcs)	254931SP	All models
<b>Mounting, wiring, cable, and adapter accessories</b>		
HMT360 retrofit mounting plate	DRW253246SP	All models
USB service cable for transmitter	219690	All models
Zener barrier for 1 channel (for 2 channels, order 2 pcs)	210664	All models
Galvanic isolator for 1 channel	212483	All models
Galvanic barrier for 1 channel	MTL5541	All models
Galvanic barrier for 2 channels (1 pc double channel)	MTL5544	All models
Calibration adapter for HMK15	211302	HMP371, HMP373, HMP374, HMP377

## Probe accessory availability

Accessory	Part number	Models
M12 Indigo USB Adapter cable accessory for connecting HMT370EX probes to Insight	USB2	All models
Ball valve ISO 1/2 with welding joint <ul style="list-style-type: none"> <li>Pressure range at +20 °C (+68 °F) 0 ... 20 bar (0 ... 290 psia) (during installation max. 10 bar (145 psia))</li> </ul>	BALLVALVE-1	HMP378
Duct installation kit	210697	HMP373, HMP377
Mounting flange	210696	HMP375
Cable gland M20 x 1.5 with split seal	HMP247CG	HMP373, HMP375, HMP377
Fitting body M22 x 1.5	17223SP	HMP374
Fitting body NPT1/2	17225SP	HMP374
Fitting body ISO1/2 solid structure	DRW212076SP	HMP378
Fitting body NPT1/2 solid structure	212810SP	HMP378
Swagelok fitting for 12mm probe, 1/2" NPT thread	SWG12NPT12	HMP377
Swagelok fitting for 12mm probe, 3/8" ISO thread	SWG12ISO38	HMP377
Swagelok fitting for 12mm probe, 1/2" ISO thread	SWG12ISO12	HMP377
Thread adapter ISO 1/2" to NPT 1/2"	210662SP	All models
Manual press	HM36854SP	HMP378/F/H

**VAISALA**

www.vaisala.com

Published by Vaisala | B211825EN-B © Vaisala Oyj 2021

All rights reserved. Any logos and/or product names are trademarks of Vaisala or its individual partners. Any reproduction, transfer, distribution or storage of information contained in this document is strictly prohibited. All specifications – technical included – are subject to change without notice.